

FLEX PVC[®] Poly Marble, Granite, Veneer & GOLD Cladding Sheets

DESIGN CATALOG with full sheet images

PVC & Natural stone composite sheets for pasting on any smooth surface including walls, furniture, old wall tiles, metal or ceilings.

- ✓ Waterproof
- ✓ Stain-resistant
- ✓ Easy Clean
- ✓ Durable
- ✓ Non-flammable
- ✓ Anti-termite
- ✓ High quality
- ✓ Fast Installation



FLEX 01 – Marble, Italian Statuario white (high gloss)

FLEX 01



FLEX 01





**FLEX 02 - Marble, Onyx white
blue green (high gloss)**

FLEX 02

FLEX 02





FLEX 03 - Marble, Italian light brown (high gloss)

FLEX 03





FLEX 04 – Marble (high gloss)





FLEX 06 - Marble, Onyx
Volcano Orange (high gloss)





FLEX 08 - Marble, Italian Beige (high gloss)





FLEX 09 - Marble, Emperador Italian Brown (high gloss)

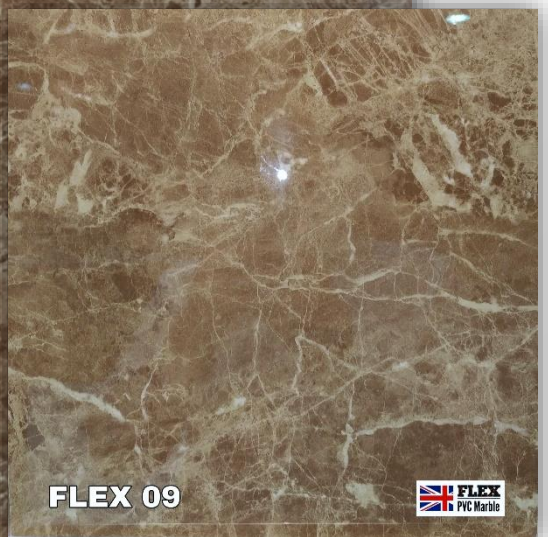
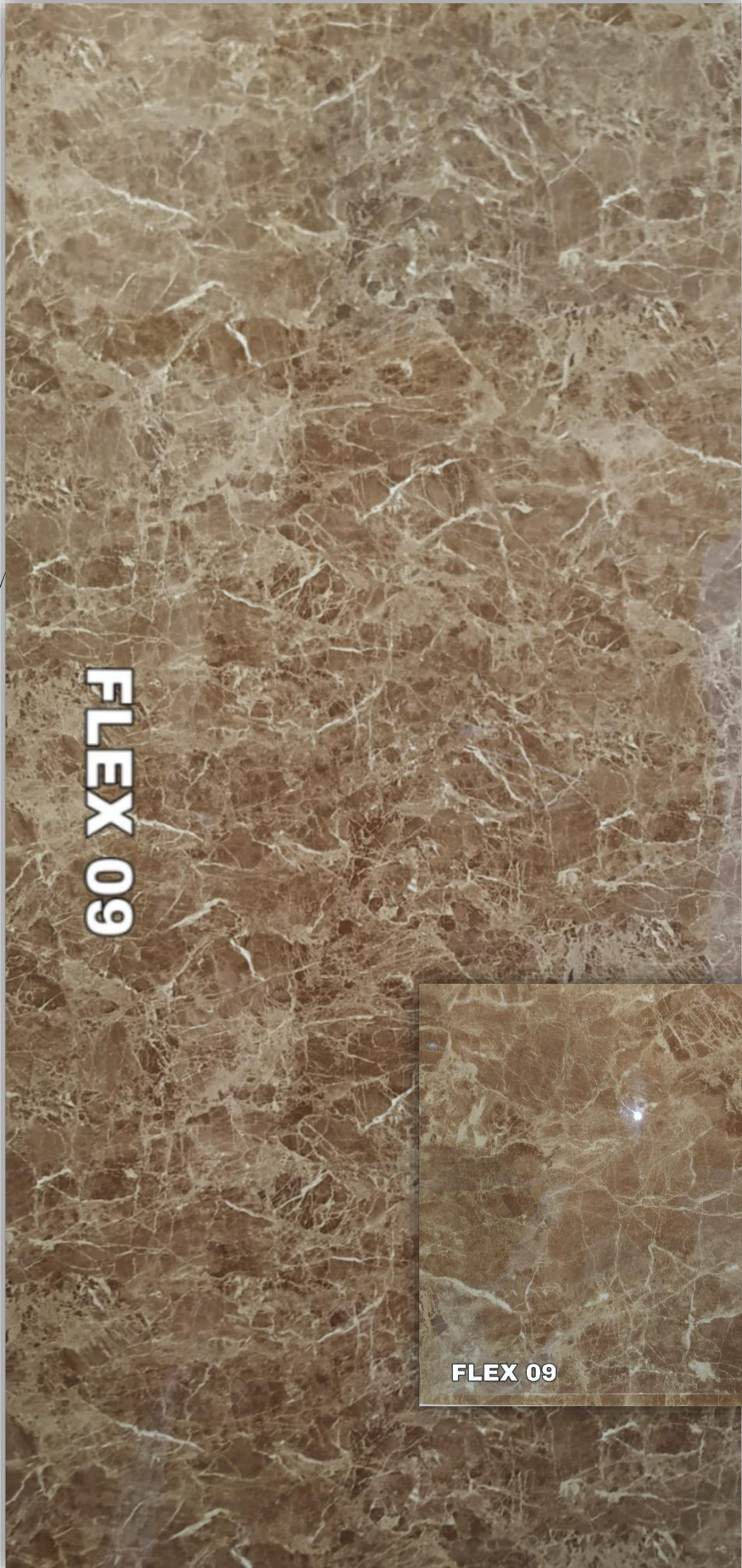



**FLEX 10 - Marble, Emperador
Italian Grey (high gloss)**





FLEX 11 - Marble, Bidasar Brown (high gloss)





FLEX 12 - Marble, Black Gold Granite (high gloss)





FLEX 12A - Marble, Black/Gold/ /White Granite (high gloss)



FLEX12A





FLEX 13 - Marble, Italian modern Onyx (high gloss)

FLEX 13

FLEX 13





FLEX 16 - Marble, Onyx Waves of Time (high gloss)





FLEX 17 – Veneer, Hazelnut
Natural Oak Wood (high
gloss)





**FLEX 18 - Veneer, Merlot
Deco Oak Wood (high
gloss)**





FLEX 19 - Veneer, Barn Oak
Polished Wood (high gloss)





**FLEX 20 - Veneer, Chesnutt
Warm Glow Wooden (high
gloss)**





**FLEX 21 - Marble, FIOR Di
Pesco Lava Onyx (high gloss)**





FLEX 22 - Marble, Himalayan
Snow Mountain Italian (high
gloss)





FLEX 23 – Marble, Italian Statuario (high gloss)





FLEX 24 – Marble Veneer Premium (high gloss)





**FLEX 25 – Marble, PURE
WHITE (high gloss)**

FLEX 25

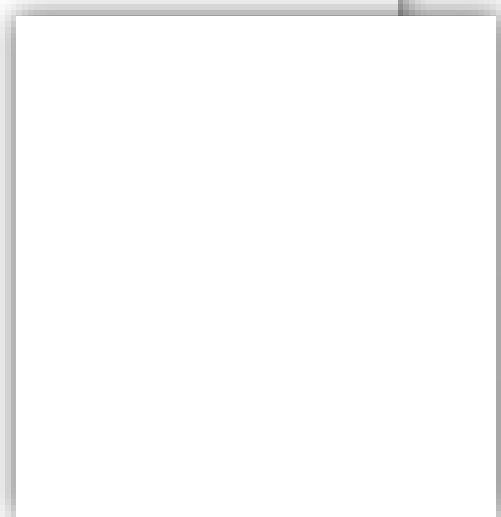



**FLEX 26 – Marble, Elegant
Light Beige (high gloss)**





**FLEX 27 – Marble, Natural
Shades of Brown (high gloss)**

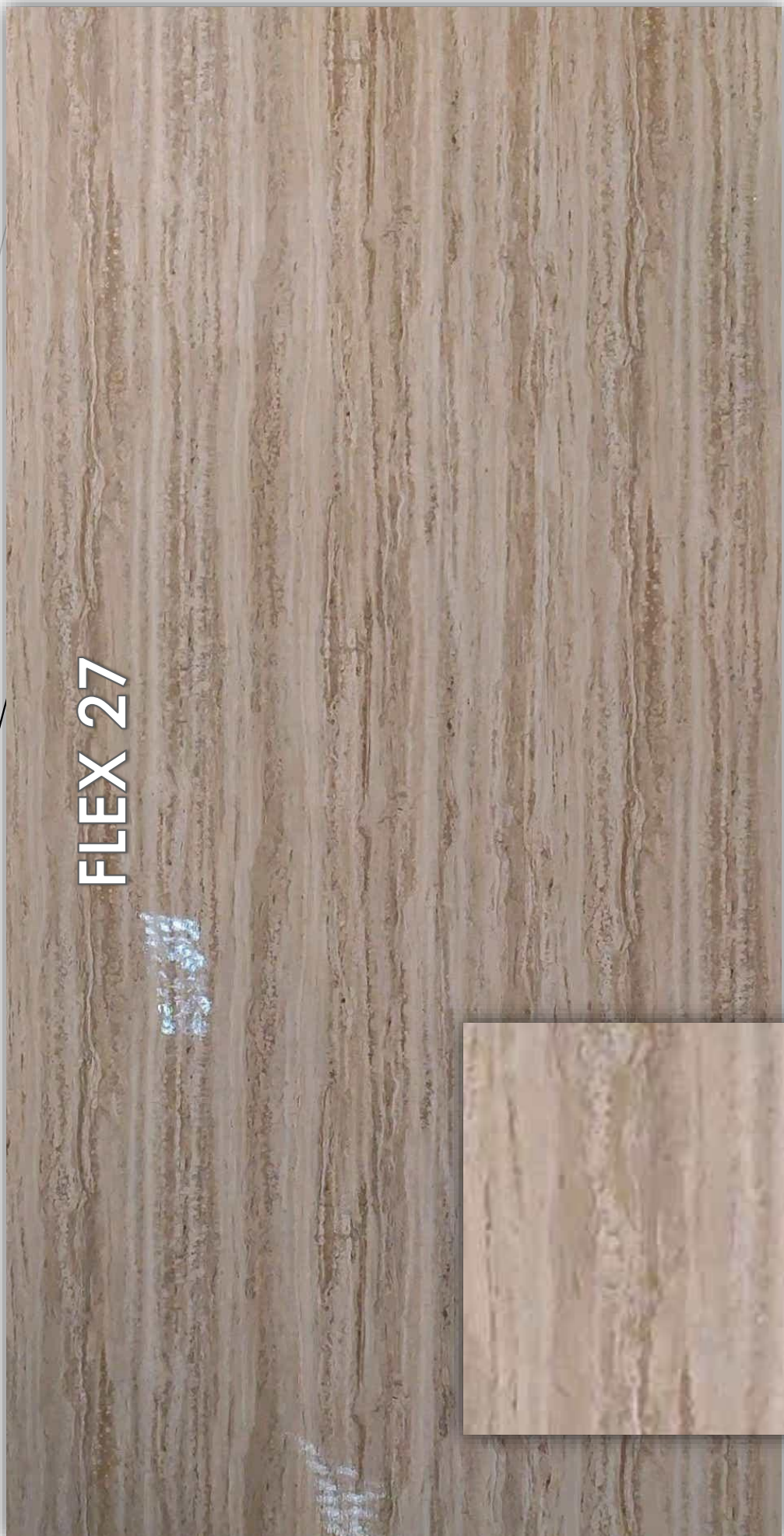



FLEX 28 – Marble Italian
WHITE Grey (high gloss)



FLEX 28





FLEX 29 – Marble Italian
WHITE Grey (high gloss)

FLEX 29





FLEX 30 - Stone, Statuario
(matte finish)

FLEX 30





FLEX 31 - Stone, LIGHT Brown
(matte finish)



FLEX 31





FLEX 32 - Stone, LIGHT Grey
(Gloss finish)





FLEX PVC® GOLD 01



FLEX G01

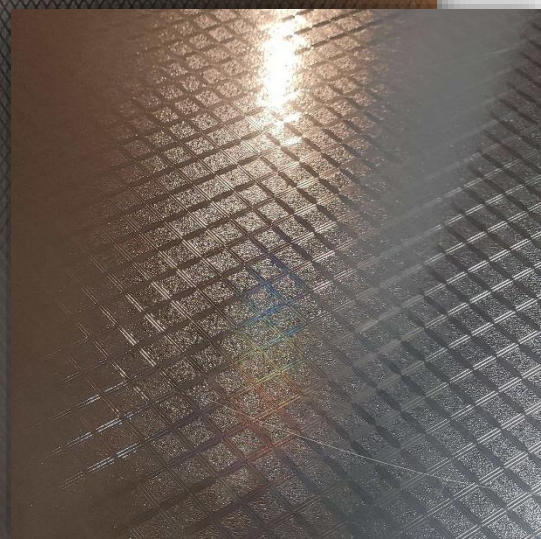



FLEX PVC® GOLD 02

FLEX G02

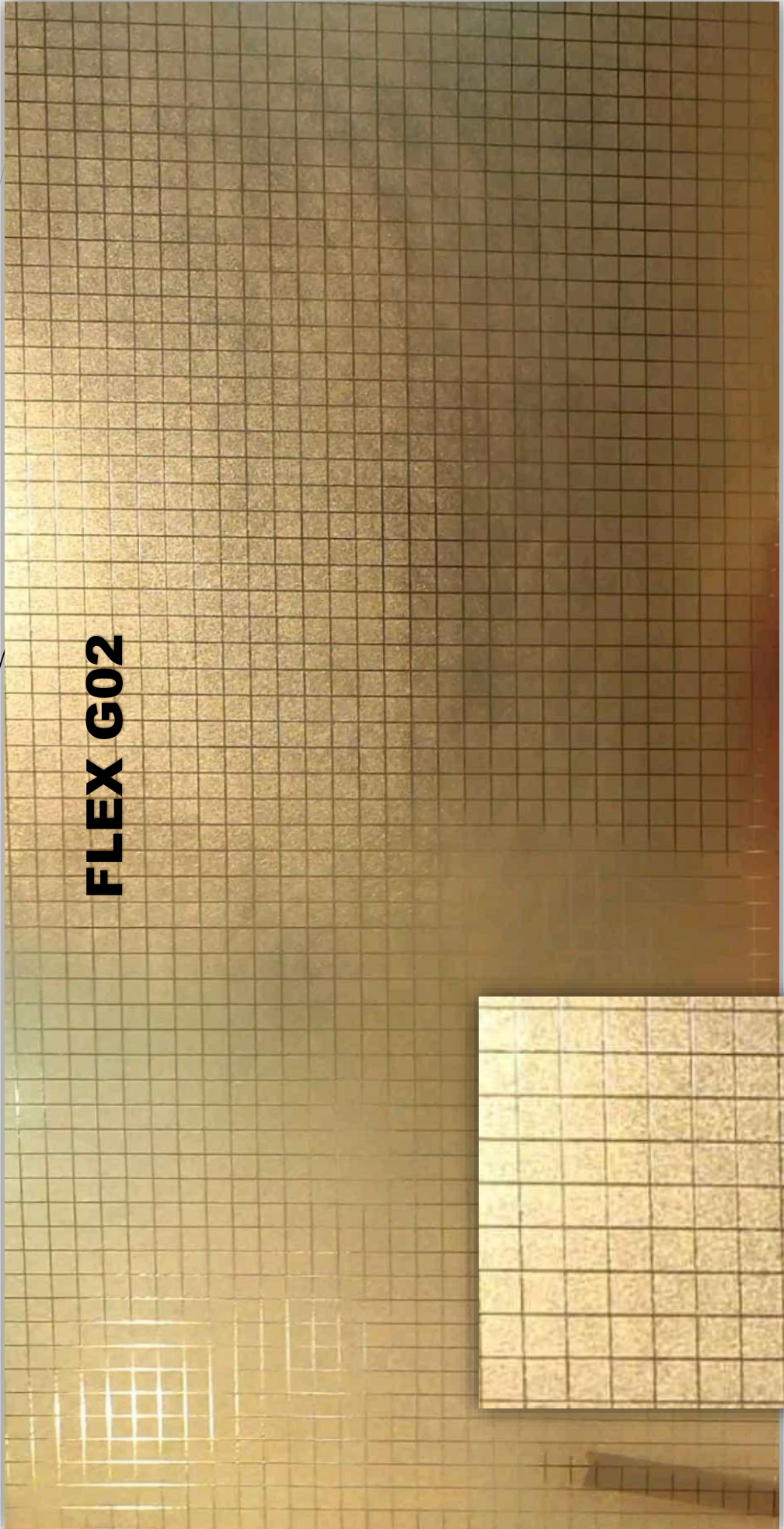



FLEX PVC® GOLD 03



FLEX G03



Introduction and Product Applications

- ▶ FLEX PVC[®] Marble, Stone & Veneer sheets can be pasted directly on any smooth surface including:
 1. **Walls** of living or bed rooms, bath room, kitchen walls, etc.
 2. On top of existing/old **wall tiles** or marble/granite
 3. **Plywood** or **WPC** boards & furniture e.g. kitchen cabinets, wardrobes, crockery units, bathroom furniture etc.
 4. **Metallic surfaces** like aluminium composite panels
 5. On Ceiling OR directly on the slab (up side down)
 6. **Wall partitions** made of **gypsum, fibre cement board** or wood

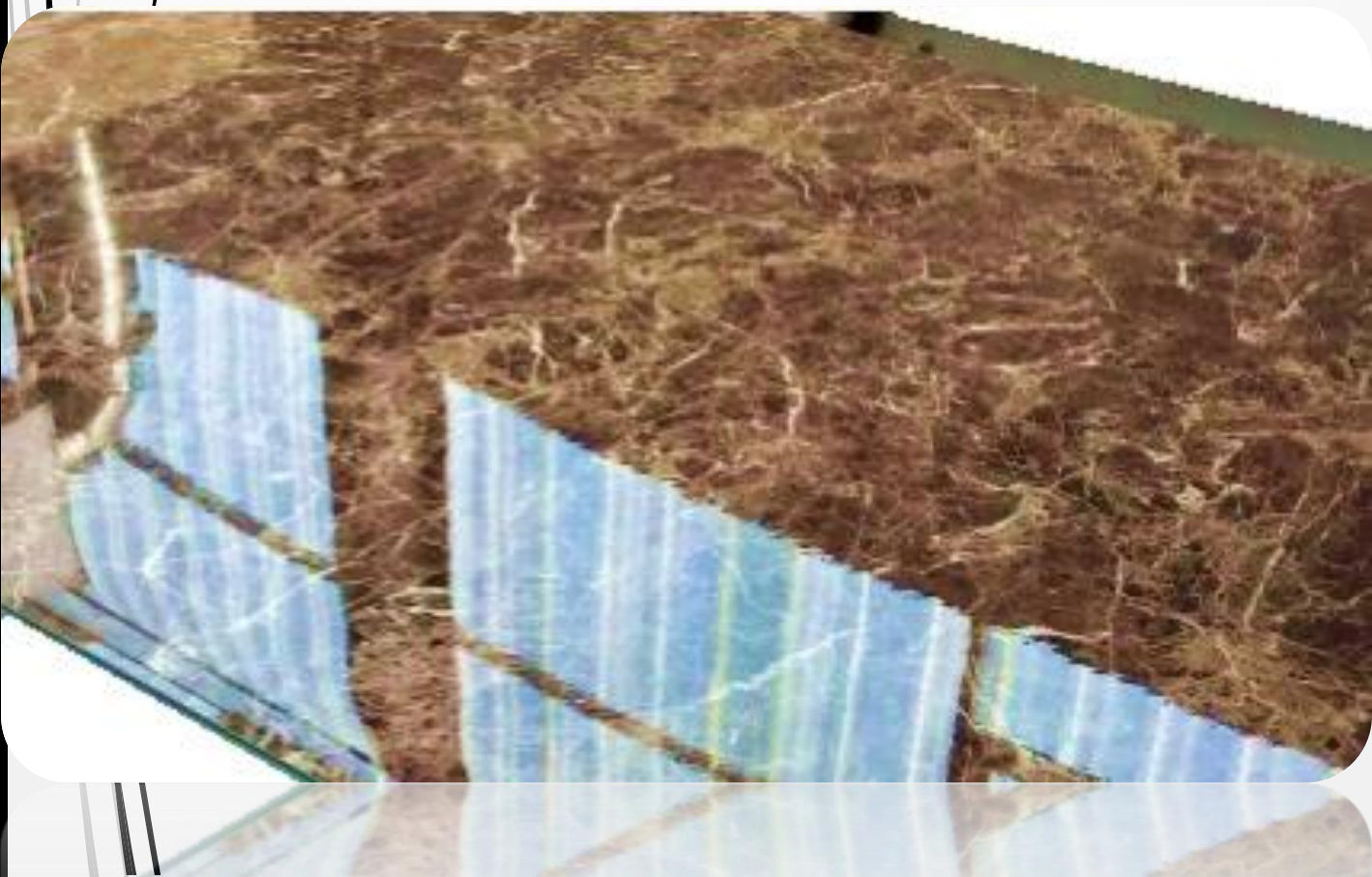



How to Install

Any carpenter can install FLEX PVC® Sheets.

Ps: Remove the protective film only at the end.

► **Pasting Adhesive**

- ✓ Fevicol Heatx for pasting on any smooth plastered/puttied/painted Walls, Old Wall Tiles, Plywood, WPC, Gypsum, Fibre Cement Board, Metal etc.
- ✓ One coat of adhesive on the pasting surface and one coat of adhesive behind the FLEX Sheets

► **Cutting and handling**

Cutting and trimming can be done using normal wood working tools. FLEX PVC® Sheets are very easy to cut.

► **Handling corner joints**

By trimming the corner edges of the sheet at a 45° angle and joining both ends (as shown in the picture)

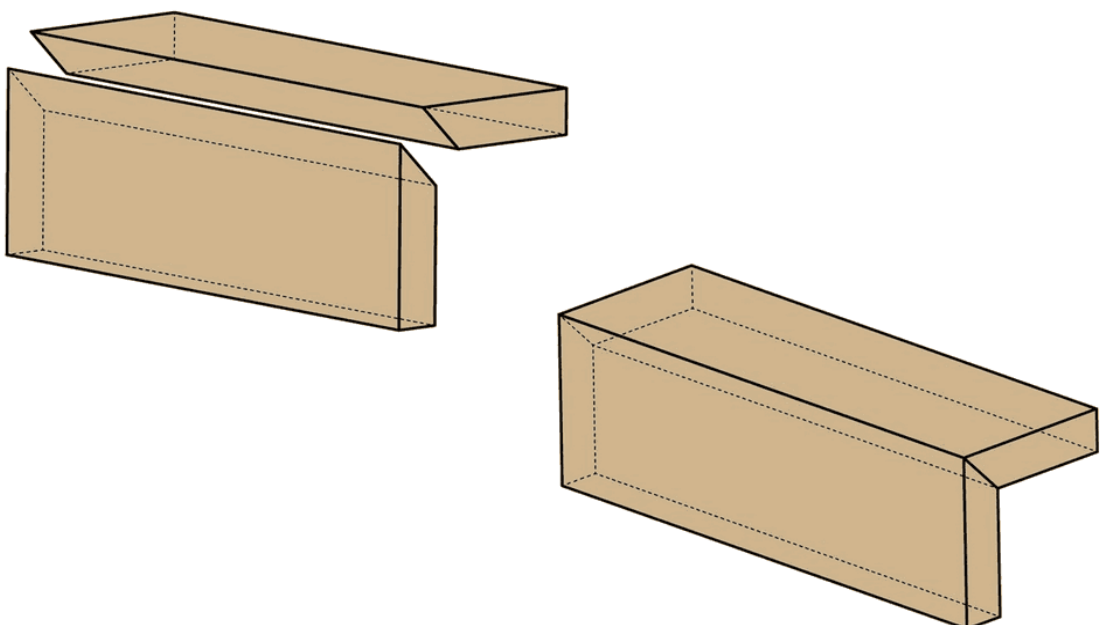



Technical Specifications

► Composition

Multi-layered, PVC and mineral composite for a long life and maximum impact in terms of finishing and gloss.

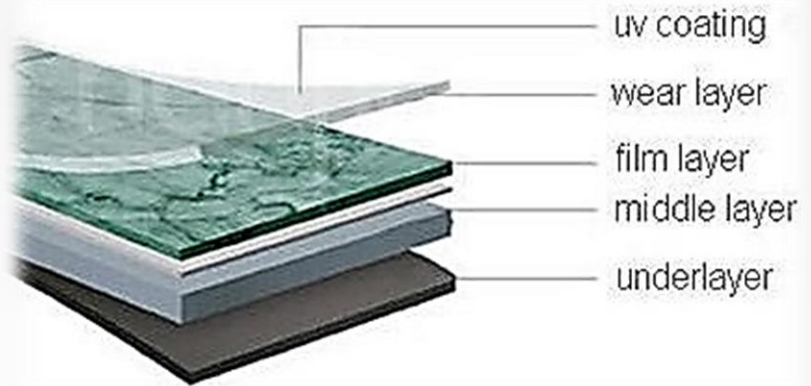

► Textured Under-layer for Superior Adhesion

The textured under-layer allows for high strength bonding on all smooth surfaces including walls, plywood, old tiles or stone, aluminium or metal surfaces etc.



► Quality Testing

High Precision and Quality Standards for Manufacturing & Testing. FLEX PVC® Sheets undergo rigorous quality standards while being manufactured to maintain the highest levels of consumer satisfaction.

► Dimensions

8 x 4 Feet, Thickness 3 mm

► Printing

Print transfer film with UV coating

► Key Benefits

Water proof, non-flammable, anti-termite, anti-bacteria, long life, zero maintenance

► Warranty

10 years fading warranty